



SAMPLE REQUEST FORM

PREPARED BY _____ DATE _____

SEND TO _____

VIA _____

☆ -INCLUDED IN SAMPLE KIT

STANDARD SAMPLES (#s 1-4)

- 14" x 16" STANDARD DOOR WITH TWO FRAMES WITH SERIAL #
 - VISIBLE INTERIOR
 - GELCOATED ENDS
- 4" x 6" DOOR SECTION THRU WINDOW AND RETAINER
 - VISIBLE INTERIOR
 - GELCOATED ENDS
- 4" x 6" CORNER DOOR SECTION WITH WINDOW
 - VISIBLE INTERIOR
 - GELCOATED ENDS
- 4" x 6" CORNER DOOR SECTION
 - VISIBLE INTERIOR
 - GELCOATED ENDS

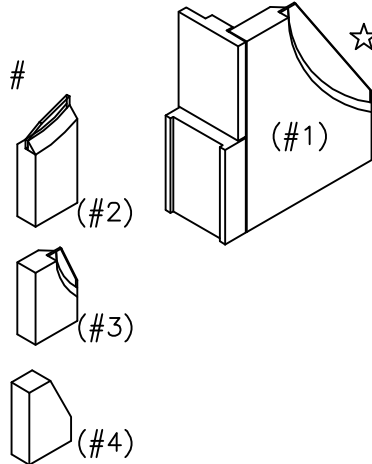

4" FRAME SECTIONS (#5)

VISIBLE INTERIOR

GELCOATED ENDS

- | | | | | | |
|---------------------|--|------------|----------------------|--|------------|
| STYLE I CP.M (#5A) | | QTY. _____ | STYLE II CP.M (#5B) | | QTY. _____ |
| STYLE IV CP.M (#5C) | | QTY. _____ | STYLE V CP.M (#5D) | | QTY. _____ |
| STYLE VI CP.M (#5E) | | QTY. _____ | STYLE VII CP.M (#5F) | | QTY. _____ |
| STYLE XI CP.M (#5G) | | QTY. _____ | STYLE IV DA (#5H) | | QTY. _____ |

4" FIRE RATED FRAME SECTIONS (#6)

VISIBLE INTERIOR

GELCOATED ENDS

- | | | | | | |
|---------------------|--|------------|---------------------|--|------------|
| STYLE I CP.M (#6A) | | QTY. _____ | STYLE II CP.M (#6B) | | QTY. _____ |
| STYLE IV CP.M (#6C) | | QTY. _____ | STYLE V CP.M (#6D) | | QTY. _____ |
| STYLE VI CP.M (#6E) | | QTY. _____ | | | |
| STYLE XI CP.M (#6F) | | QTY. _____ | | | |



SAMPLE REQUEST FORM

☆ - INCLUDED IN SAMPLE KIT

VISIBLE INTERIOR

GELCOATED ENDS

WALL WINDOW FRAME SECTIONS WITH RETAINER (#7)

STYLE I (#7A)

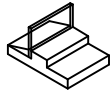

QTY. _____

STYLE I MULLION (#7C)

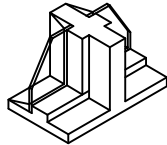

QTY. _____

STYLE IV CP.M 90° (#7E)

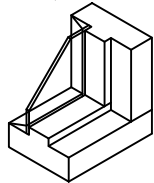

QTY. _____

STYLE V CP.M (#7G)

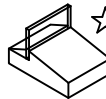

QTY. _____

STYLE V MULLION (#7I)

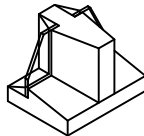

QTY. _____

STYLE VI CP.M 90° (#7K)

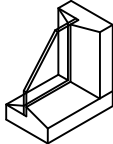

QTY. _____

STYLE VII CP.M (#7M)

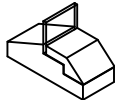

QTY. _____

STYLE I CP.M 90° (#7B)

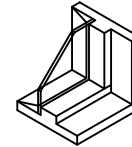

QTY. _____

STYLE IV CP.M (#7D)

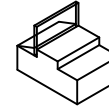

QTY. _____

STYLE IV MULLION (#7F)

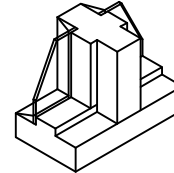

QTY. _____

STYLE V CP.M 90° (#7H)

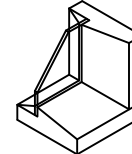

QTY. _____

STYLE VI CP.M (#7J)

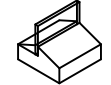

QTY. _____

STYLE VI MULLION (#7L)

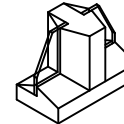

QTY. _____

STYLE XI CP.M (#7N)

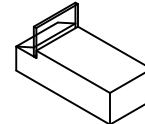

QTY. _____

STYLE IX MULLION (#7O)

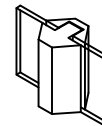

QTY. _____

COLOR SAMPLES (#8) ☆

QTY. _____

FRP ASTRAGAL (#9) ☆

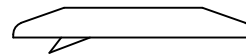

QTY. _____

FRP THRESHOLD (#10) ☆

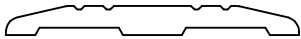

QTY. _____

FRP SWEEP (#11) ☆

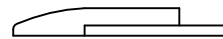

QTY. _____

FRP WEATHERSTRIP (BULB SEAL) (#12) ☆



QTY. _____

PURPOSE _____

OK'D BY _____ DATE _____

1-800-444-6924 / FAX: (956) 544-7943

ORDER SHEET 2-7
REV 7

NAME: SAMPLE REQUEST
DATE: 02/01